

Fender 300 PS

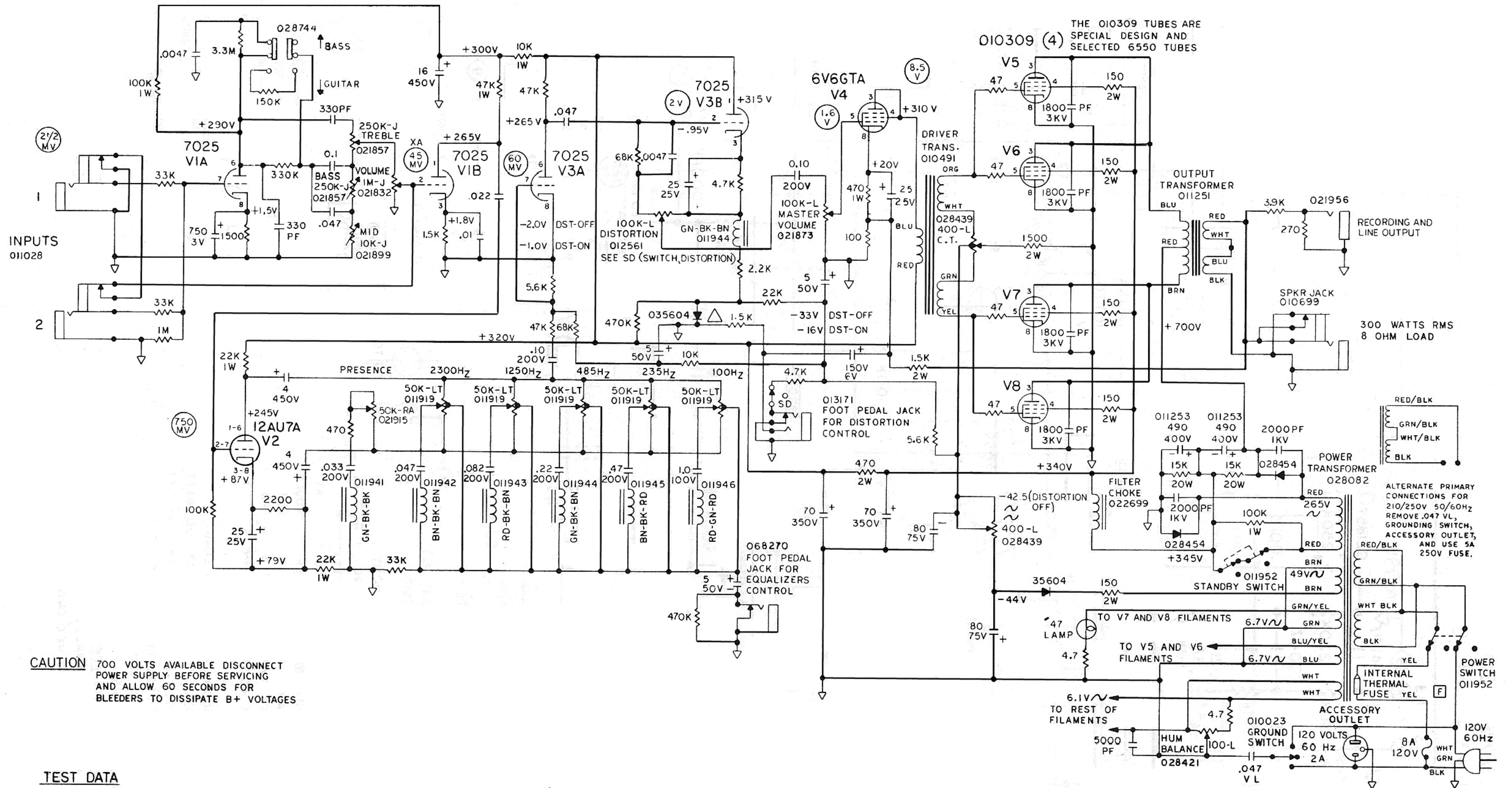

THE 6550 TUBES ARE SPECIAL DESIGN AND SELECTED 6550 TUBES

CAUTION 700 VOLTS AVAILABLE DISCONNECT POWER SUPPLY BEFORE SERVICING AND ALLOW 60 SECONDS FOR BLEEDERS TO DISSIPATE B+ VOLTAGES

TEST DATA

(MV) DENOTES NOMINAL 1KHz SIGNAL FOR 10 WATTS OUTPUT.
 CONTROL SETTING - EQUALIZERS AND PRESENCE AT MID POSITION.
 DISTORTION AT MINIMUM. BASS/GUITAR SWITCH SET FOR GUITAR OTHERS AT MAXIMUM. FOOT PEDALS NOT PLUGGED INTO JACKS.

-USE 0.1MFD 600V CAPACITOR IN SERIES WITH GENERATOR.
 XA - INSERT DUMMY PLUG INTO INPUT JACK. Δ 035604 CONDUCTS WITH DISTORTION "ON".
 D.C. VOLTAGES READ WITH NO SIGNAL INPUT. [F] USED IN SOME VERSIONS

2. ALL RESISTORS ARE 1/2W, 10%.
 1. ALL CAPACITORS AT LEAST 600 W.V.D.C.
 NOTES: UNLESS OTHERWISE SPECIFIED